

Price List

Your local timber
merchant and
manufacturer

Pat'erns

Network UK Ltd.

AUGUST 2023



GREAT VALUE GARDEN DECKING BOARDS

Page 12

FEATURING



SKIRTING

PAGE 7



RAILWAY SLEEPERS

PAGE 22



COLOURED FENCE POSTS

PAGE 23

About us

Based in Stephenson Road on the Gorse Lane Industrial Estate, Clacton on Sea, Pat'erns Network UK Limited is undoubtedly one of the most popular and successful businesses in the area.

Pat'erns was established more than 40 years ago by Patrick Pigram. A family-run business, it supplies to trade and public alike.

Primarily a supplier of timber and machined goods from DIY, mouldings, sheet materials, garden sheds and summerhouses, gates, ironmongery, concrete products and virtually anything else you need to complete your project.

We can cut to size and specification, and if what you require isn't in stock, we will do our utmost to obtain it for you.

We at Pat'erns pride ourselves on our friendly service and competitive prices. We constantly seek to offer a wider and better range of products to an ever-increasing number of customers. Whatever you need, Pat'erns will aim to cater for all your requirements.



Timber



Treated Sawn Softwood

| KD Planer Reg. C-16/24 Graded Sawn Softwood Treated Timber (per metre) | | | |
|---|-------|-----------|--------|
| 25 x 25 | £0.50 | 225 x 38 | £5.45 |
| 50 x 25 | £1.05 | 50 x 47 | £1.25 |
| 75 x 25 | £1.15 | 75 x 47 | £1.90 |
| 100 x 25 | £1.55 | 100 x 47 | £2.50 |
| 125 x 25 | £1.95 | 125 x 47 | £3.15 |
| 150 x 25 | £2.35 | 150 x 47 | £3.75 |
| 175 x 25 | £2.70 | 175 x 47 | £4.40 |
| 200 x 25 | £3.10 | 200 x 47 | £5.00 |
| 225 x 25 | £3.50 | 225 x 47 | £5.65 |
| 19 x 38 | £0.65 | 75 x 75 | £4.05 |
| 25 x 38 | £0.90 | 75 x 100 | £5.40 |
| 38 x 38 | £0.95 | 75 x 125 | £6.80 |
| 50 x 38 | £1.25 | 75 x 150 | £8.10 |
| 75 x 38 | £1.80 | 75 x 175 | £9.50 |
| 100 x 38 | £2.45 | 75 x 200 | £10.85 |
| 125 x 38 | £3.00 | 75 x 225 | £12.20 |
| 150 x 38 | £3.60 | 100 x 100 | £7.20 |
| 175 x 38 | £4.25 | 100 x 150 | £10.85 |
| 200 x 38 | £4.85 | 100 x 200 | £14.45 |

Prepared Timber

| Prepared Timber Nominal sizes (per metre) | | | |
|--|--------|-----------|--------|
| 25 x 25 | £1.30 | 225 x 38 | £12.75 |
| 50 x 25 | £1.50 | 50 x 50 | £3.35 |
| 75 x 25 | £2.10 | 75 x 50 | £5.00 |
| 100 x 25 | £2.85 | 100 x 50 | £6.70 |
| 125 x 25 | £3.60 | 125 x 50 | £7.85 |
| 150 x 25 | £4.25 | 150 x 50 | £8.98 |
| 175 x 25 | £5.90 | 175 x 50 | £9.89 |
| 200 x 25 | £7.05 | 200 x 50 | £10.15 |
| 225 x 25 | £8.15 | 225 x 50 | £11.65 |
| 19 x 38 | £1.30 | 75 x 75 | £6.85 |
| 25 x 38 | £1.55 | 75 x 100 | £8.85 |
| 38 x 38 | £2.15 | 75 x 125 | £10.65 |
| 50 x 38 | £2.90 | 75 x 150 | £12.15 |
| 75 x 38 | £3.85 | 75 x 175 | £17.60 |
| 100 x 38 | £5.35 | 75 x 200 | £20.35 |
| 125 x 38 | £6.50 | 75 x 225 | £23.10 |
| 150 x 38 | £7.75 | 100 x 100 | £13.75 |
| 175 x 38 | £9.65 | 100 x 150 | £19.10 |
| 200 x 38 | £10.95 | 100 x 200 | £26.85 |

All prices include VAT

Timber contd.

CLS and Feather Edge Timber



| CLS Timber (nominal sizes) | | |
|--------------------------------------|------|-------------|
| 50x75mm Finished size 38x63mm | 2.4m | £4.75 each |
| | 3.0m | £5.95 each |
| | 4.8m | £9.80 each |
| 50x100mm Finished size 38x89mm | 2.4m | £6.35 each |
| | 3.0m | £7.95 each |
| | 4.8m | £13.10 each |



| Brown Treated Feather Edge (Ex 22 x 125) | | |
|---|------------|--|
| 2.4 | £2.15 each | |
| 2.1 | £1.90 each | |
| 1.8 | £1.60 each | |
| 1.5 | £1.35 each | |
| 1.2 | £1.10 each | |
| 0.900 | £0.80 each | |

| Black Treated Feather Edge | | |
|----------------------------|-------------|--|
| 3.6 | £10.40 each | |
| 4.2 | £12.15 each | |
| 4.8 | £13.85 each | |

| Green Treated Feather Edge | | |
|----------------------------|-----------------|--|
| Ex 22x150 | £1.30 per metre | |
| Ex 32x175 | £2.20 per metre | |

Firring Pieces



| Firring Pieces | | |
|----------------|-----------------|--|
| 50mm | £1.15 per metre | |
| 75mm | £1.70 per metre | |
| 100mm | £2.25 per metre | |

Timber contd.

Roofing Timber



| Arris Rail | |
|------------|-----------------|
| 47mm | £1.15 per metre |
| 75mm | £2.60 per metre |

| Cant Rail Ex. | |
|---------------|-----------------|
| 125x47mm | £2.65 per metre |

| Lead Wood-Core Roll | |
|---------------------|-----------------|
| 47x50mm | £4.60 per metre |

Softwood & Hardwood Mouldings

Shiplap & Loglap Cladding



| Shiplap (Redwood) | |
|-------------------|-----------------|
| 16 x 125mm | £2.25 per metre |
| 19 x 125mm | £2.50 per metre |
| 25 x 150mm | £4.15 per metre |



| Loglap | |
|------------|-----------------|
| 25 x 100mm | £3.30 per metre |
| 25 x 125mm | £3.95 per metre |
| 38 x 100mm | To order |
| 38 x 125mm | To order |

All prices include VAT

Softwood & Hardwood Mouldings contd.

T&G Flooring



| T&G Flooring (Redwood) | |
|------------------------|-----------------|
| 19 x 125mm | £2.35 per metre |
| 25 x 125mm | £3.45 per metre |
| 25 x 150mm | £4.25 per metre |

Cladding



| T&G Beaded Cladding | |
|---------------------|-----------------|
| 19mm x 100mm (Nom) | £1.90 per metre |
| 19mm x 125mm (Nom) | £2.35 per metre |

Window Board



| Window Board (Pine) | |
|---------------------|------------------|
| 32 x 150mm | £8.95 per metre |
| 32 x 225mm | £12.25 per metre |

| Window Board (Hardwood) | |
|-------------------------|------------------|
| 32 x 150mm | £25.75 per metre |
| 32 x 225mm | £38.65 per metre |

| M.D.F. Window Board | |
|---------------------|------------------|
| 25 x 169mm | £7.25 per metre |
| 25 x 219mm | £9.30 per metre |
| 25 x 244mm | £10.35 per metre |
| 25 x 269mm | £11.35 per metre |
| 25 x 294mm | £12.40 per metre |

| PMV Cladding (Redwood) | |
|------------------------|-----------------|
| 12 x 100mm (Nom) | £1.55 per metre |

Matching



| Matching (Redwood) | |
|--------------------|-----------------|
| 18 x 100mm | £1.90 per metre |
| 18 x 125mm | £2.35 per metre |

Picture / Dado Rails

| Picture / Dado Rails | |
|----------------------|-----------------|
| - | £3.95 per metre |

| M.D.F. Dado Rail | |
|----------------------|------------|
| 58mm x 4.4 per metre | £9.95 each |

Softwood & Hardwood Mouldings contd.

Window Cill



| Window Cill (Pine) | |
|------------------------|------------------|
| 50 x 150mm | £10.30 per metre |
| Window Cill (Hardwood) | |
| 50 x 150mm | £33.85 per metre |

Handrails



| Handrail | |
|------------------|-----------------|
| Wall / Pigs Ear | £7.95 per metre |
| Mopstick | £4.95 per metre |
| Banister (Crown) | £4.50 per metre |
| Bottom Rail | £4.25 per metre |

Door Linings



| Door Linings | |
|--------------------|-----------------|
| Lengths 32 x 115mm | £4.25 per metre |
| Lengths 32 x 138mm | £5.10 per metre |
| Sets 115 x 32mm | £20.20 each |
| Sets 138 x 32mm | £23.60 each |
| Sets 175 x 32mm | £28.10 each |

Door Drips & Stops



| Door Drips | |
|------------------------|------------------|
| Pine - 41 x 64mm | £7.45 per metre |
| Hardwood - 41 x 64mm | £15.95 per metre |
| Door Stop (Standard) | |
| 12 x 34mm* | £0.99 per metre |
| Door Stop (Fire Check) | |
| 25 x 45mm* | £2.05 per metre |

* Finished size

All prices include VAT

Softwood & Hardwood Mouldings contd.

Skirting and Architrave



Skirting & Architrave (Large Size)

| | |
|------------|------------------------|
| 25 x 225mm | £8.85 per metre |
| 25 x 200mm | £7.75 per metre |
| 25 x 175mm | £6.65 per metre |
| 25 x 150mm | £4.95 per metre |
| 25 x 125mm | £4.35 per metre |
| 25 x 100mm | £3.70 per metre |
| 25 x 75mm | £3.05 per metre |
| 25 x 63mm | £2.95 per metre |
| 25 x 50mm | £2.45 per metre |

Ovolo / O-Gee Chamfered / Bullnose Skirtings & Architrave small standard

| | |
|------------|------------------------|
| 18 x 150mm | £2.90 per metre |
| 18 x 125mm | £2.50 per metre |
| 18 x 100mm | £2.20 per metre |
| 18 x 75mm | £1.95 per metre |
| 18 x 63mm | £1.70 per metre |
| 18 x 50mm | £1.50 per metre |



M.D.F. Primed Mouldings Torus / Ovolo / O-Gee Skirtings & Architrave

| | |
|--------------------------|--------------------|
| 18 x 58 x 4.4 per metre | £8.60 each |
| 18 x 69 x 4.4 per metre | £10.10 each |
| 18 x 94 x 4.4 per metre | £13.45 each |
| 18 x 119 x 4.4 per metre | £16.80 each |
| 18 x 144 x 4.4 per metre | £20.15 each |
| 18 x 169 x 4.4 per metre | £23.55 each |

M.D.F Chamfered and Round

| | |
|-------------------------|--------------------|
| 18 x 44 x 4.4 per metre | £6.75 each |
| 18 x 94 x 4.4 per metre | £13.45 each |

Sheet Materials & Plasterboard

Plywood



| Marine | | |
|--------|---------------|--------|
| 12mm | 2440 x 1220mm | £50.75 |
| 18mm | 2440 x 1220mm | £79.65 |

| W.B.P. Pine Faced Ply (Elliotis) | | |
|----------------------------------|---------------|--------|
| 9mm | 2440 x 1220mm | £24.30 |
| 12mm | 2440 x 1220mm | £30.40 |
| 18mm | 2440 x 1220mm | £41.60 |

| W.B.P. Hardwood Faced Ply | | |
|---------------------------|---------------|--------|
| 3.6mm | 2440 x 1220mm | £14.85 |
| 5.5mm | 2440 x 1220mm | £16.75 |
| 9mm | 2440 x 1220mm | £23.75 |
| 12mm | 2440 x 1220mm | £32.60 |
| 18mm | 2440 x 1220mm | £45.45 |
| 25mm | 2440 x 1220mm | £82.65 |

Chipboard



| Standard Grade Chipboard | | |
|--------------------------|---------------|----------|
| 18mm | 2440 x 1220mm | To order |

| T&G Chipboard Flooring | | |
|------------------------|---------------|--------|
| 18mm | MR 2440x600mm | £22.00 |
| 22mm | MR 2440x600mm | £26.00 |

| T&G O.S.B. Sterling Board | | |
|---------------------------|--------------|--------|
| 18mm | 2440 x 600mm | £22.80 |

O.S.B3 Sterling Board



| O.S.B. Sterling Board | | |
|-----------------------|---------------|--------|
| 11mm | 2440 x 1220mm | £20.90 |
| 18mm | 2440 x 1220mm | £32.55 |

We also stock
Damp Proof Membrane



| | | |
|---------------|----------|--------|
| DPM BBA 250mu | 4m x 25m | £49.15 |
| DPM BBA 300mu | 4m x 25m | £55.65 |

All prices include VAT

Sheet Materials & Plasterboard contd.

MDF



| Medium Density Fibreboard (MDF) | | |
|---------------------------------|---------------|--------|
| 6mm | 2440 x 1220mm | £21.35 |
| 9mm | 2440 x 1220mm | £26.95 |
| 12mm | 2440 x 1220mm | £33.15 |
| 15mm | 2440 x 1220mm | £37.85 |
| 18mm | 2440 x 1220mm | £42.30 |
| 25mm | 2440 x 1220mm | £69.75 |

| White Faced M.D.F. | | |
|--------------------|---------------|--------|
| 3.2mm | 2440 x 1220mm | £12.40 |

Hardboard



| Hardboard | | |
|-----------|---------------|-------|
| 3.2mm | 2440 x 1220mm | £8.30 |

Plasterboard



| Plasterboard (Standard) | | |
|-------------------------|-----|--------|
| 2400 x 1200 x 12.5mm | S/E | £11.55 |
| 2400 x 1200 x 12.5mm | T/E | £11.55 |
| 2400 x 1200 x 9.5mm | S/E | £11.55 |
| 1800 x 900 x 12.5mm | S/E | £8.50 |
| 1800 x 900 x 9.5mm | S/E | £8.50 |

| Plasterboard (Moisture Resistant) | | |
|-----------------------------------|-----|--------|
| 2400 x 1200 x 12.5mm | S/E | £19.30 |
| 2400 x 1200 x 1 2.5mm | T/E | £19.30 |

| Plasterboard (Fire Resistant) | | |
|-------------------------------|-----|--------|
| 2400 x 1200 x 12.5mm | S/E | £15.15 |
| 2400 x 1200 x 1 2.5mm | T/E | £15.15 |

| Plasterboard (Vapour Check) | | |
|-----------------------------|-----|--------|
| 2400 x 1200 x 12.5mm | S/E | £16.80 |

Plasterboard Accessories

| Accessories | |
|--|--------|
| Thistle Bonding Coat - 25kg Bag | £15.25 |
| Thistle Multifinish Plaster - 25kg Bag | £11.25 |
| Knauf Plasterboard Adhesive - 25kg Bag | £10.55 |

Sheet Materials & Plasterboard contd.

Phenolic Ply

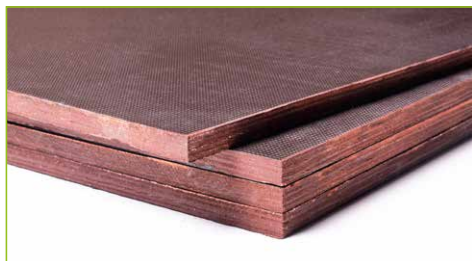

| Phenolic Ply | | |
|--------------|---------------|--------|
| 6mm | 2440 x 1220mm | £21.35 |
| 9mm | 2440 x 1220mm | £26.95 |
| 12mm | 2440 x 1220mm | £33.15 |
| 15mm | 2440 x 1220mm | £37.85 |
| 18mm | 2440 x 1220mm | £42.30 |
| 25mm | 2440 x 1220mm | £69.75 |

Cladded Panels



| Cladded Panels | | |
|----------------|---------------|--------|
| 6mm | 2440 x 1220mm | £21.35 |
| 9mm | 2440 x 1220mm | £26.95 |
| 12mm | 2440 x 1220mm | £33.15 |
| 15mm | 2440 x 1220mm | £37.85 |
| 18mm | 2440 x 1220mm | £42.30 |
| 25mm | 2440 x 1220mm | £69.75 |

Sundeala Board



| Sundeala Board | | |
|----------------|---------------|--------|
| 6mm | 2440 x 1220mm | £21.35 |
| 9mm | 2440 x 1220mm | £26.95 |
| 12mm | 2440 x 1220mm | £33.15 |
| 15mm | 2440 x 1220mm | £37.85 |
| 18mm | 2440 x 1220mm | £42.30 |
| 25mm | 2440 x 1220mm | £69.75 |

Celotex PIR Insulation



| Celotex High Performance PIR Insulation | | |
|---|---------------|--------|
| 25mm | 2400 x 1200mm | £22.20 |
| 50mm | 2400 x 1200mm | £34.20 |
| 75mm | 2400 x 1200mm | £49.05 |
| 100mm | 2400 x 1200mm | £60.00 |
| 120mm | 2400 x 1200mm | £74.30 |
| 150mm | 2400 x 1200mm | £90.40 |

* Other sizes available to order

All prices include VAT

Sheet Materials & Plasterboard contd.

Radiator Screens

Decorative grilles ideal for radiator covers.

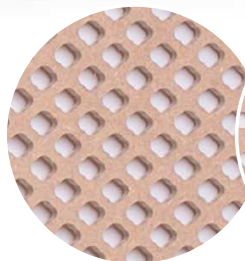
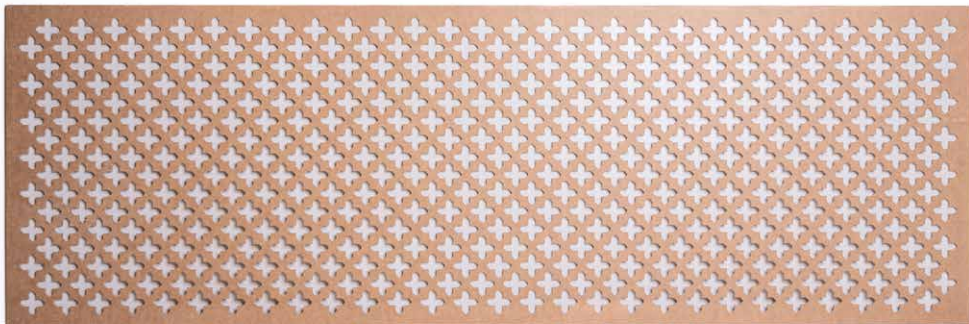

Nevada

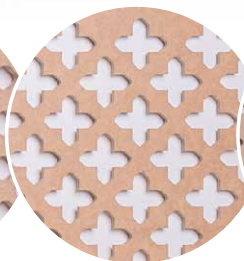

Oregon

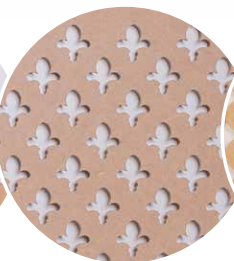

Fleur-de-lys

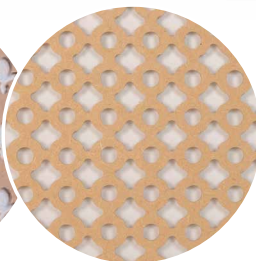

Ohio

| Radiator Screen | | |
|-----------------|--------------|--------|
| 6mm | 1830 x 610mm | £39.25 |



C.C.A. Green Treated Decking & Accessories

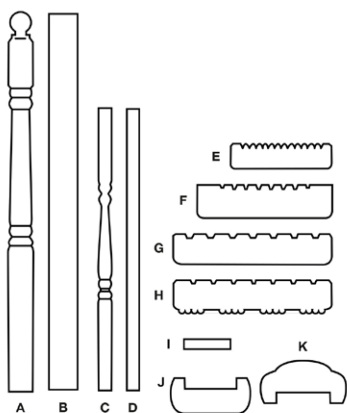

| Decking and Accessories | |
|---|--------------|
| A - 82mm x 82mm turned newel post | £18.75 each |
| B - 100mm square newel post 4 eased edges | £14.95 metre |
| C - 41mm turned spindle 900mm | £2.95 each |
| D - 41mm square spindle 900mm | £2.75 each |
| E - 32mm x 100mm Decking | To order |
| F - 32mm x 125mm Decking | £3.50 metre |
| G - 38mm x 125mm Decking | To order |
| H - 32mm x 150mm Decking Reversible | £4.20 metre |
| I - 12mm x 41mm Infill | 99p metre |
| J - 25mm x 75mm Bottom Rail | £3.95 metre |
| K - 50mm x 75mm Hand Rail | £3.95 metre |



All prices include VAT

Sheds & Beach Huts

Pat'erns is a UK-based company, who have over 40 years of experience manufacturing and creating quality, long-lasting garden buildings and outdoor storage.

Bespoke Sheds & Summer Houses

In our mill and workshop, we can make your timber sheds, summer houses and outdoor spaces specific to your requirements, in a variety of shapes, styles and sizes. By using our own on-site mill and workshop, we can ensure that our sheds and summer houses are finished to the highest standards.

Beach Huts

Our custom-made beach huts are designed and built to Tendring District Council specifications. All beach huts are made in our workshop, and so the design can be tailored to include customer's specific requests.

We not only design, manufacture and install brand new custom-made beach huts, but we also provide a hut-repair service for those older beach huts in need of a little tender loving care.

Our prices include professional installation.

We can also offer gates and fences that are custom-made in our workshop



Heavy Duty Sheds

All sheds are treated and erected. Perspex windows supplied to chosen design.

| Feet/Inches | Metres | Price |
|-------------|-----------|----------|
| 4ft x 6ft | 1.2 x 1.8 | £400.00 |
| 4ft x 7ft | 1.2 x 2.1 | £465.00 |
| 4ft x 8ft | 1.2 x 2.4 | £530.00 |
| 4ft x 9ft | 1.2 x 2.7 | £595.00 |
| 5ft x 5ft | 1.5 x 1.5 | £415.00 |
| 5ft x 6ft | 1.5 x 1.8 | £495.00 |
| 5ft x 7ft | 1.5 x 2.1 | £575.00 |
| 5ft x 8ft | 1.5 x 2.4 | £655.00 |
| 5ft x 9ft | 1.5 x 2.7 | £735.00 |
| 6ft x 6ft | 1.8 x 1.8 | £595.00 |
| 6ft x 7ft | 1.8 x 2.1 | £690.00 |
| 6ft x 8ft | 1.8 x 2.4 | £785.00 |
| 6ft x 9ft | 1.8 x 2.7 | £880.00 |
| 6ft x 10ft | 1.8 x 3.0 | £975.00 |
| 6ft x 12ft | 1.8 x 3.6 | £1170.00 |
| 7ft x 7ft | 2.1 x 2.1 | £800.00 |
| 7ft x 8ft | 2.1 x 2.4 | £915.00 |
| 7ft x 9ft | 2.1 x 2.7 | £1025.00 |
| 7ft x 10ft | 2.1 x 3.0 | £1135.00 |
| 7ft x 12ft | 2.1 x 3.6 | £1360.00 |
| 8ft x 8ft | 2.4 x 2.4 | £1040.00 |
| 8ft x 9ft | 2.4 x 2.7 | £1170.00 |
| 8ft x 10ft | 2.4 x 3.0 | £1295.00 |
| 8ft x 12ft | 2.4 x 3.6 | £1555.00 |
| 10ft x 12ft | 3.0 x 3.6 | £1995.00 |
| 10ft x 16ft | 3.0 x 4.8 | £2655.00 |
| 10ft x 20ft | 3.0 x 6.0 | £3315.00 |

| Shed additions | |
|----------------------------|-------------|
| Standard double doors plus | £100.00 |
| F.L.B. Double doors plus | £195.00 |
| Open window | £80.00 each |

Weatherboard, shiplap, apex, or pent roof styles.



TYPE 1



TYPE 2



TYPE 3



TYPE 4



TYPE 5



TYPE 6

SHEDS ARE ERECTED ON CUSTOMERS' OWN BASES.

Please make sure your base is level and the right size. No responsibility can be taken for the appropriateness of customers' existing bases.

Pat'erns do offer a service where we provide the appropriate base for a shed.

ALL PRICES ABOVE INCLUDE VAT AND FREE DELIVERY

Sizes stated are approximate. Other bespoke sizes can be made. Please contact in store for further details and prices. Delivery is free in the Tending area.

All prices include VAT

Tool Sheds & Bin Boxes

| Tool Sheds | |
|------------|----------------|
| 3ft x 3ft | £175.00 |
| 3ft x 4ft | £235.00 |
| 3ft x 5ft | £295.00 |
| 3ft x 6ft | £350.00 |
| 4ft x 4ft | £315.00 |
| 4ft x 5ft | £390.00 |

| Bin Boxes | |
|---------------------------|----------------|
| D 3ft x W 5ft x H 2ft 6in | £225.00 |
| D 3ft x W 6ft x H 3ft | £270.00 |
| D 2ft 6in x W 4ft x H 2ft | £150.00 |

Beach Huts

To Tendring District Council specifications.

| Beach Huts | |
|--|-----------------|
| Remove old beach hut from site | £500.00 |
| New beach hut including 6mm Plywood Lining | £5000.00 |
| Front shutters | £500.00 |
| Wire rope | £200.00 |
| Installation | £400.00 |



Summer Houses

Custom-made to your design.
Treated and erected on a base supplied by you.

Example price:
8ft x 6ft = £1450.00

Shed Accessories

We supply all shed accessories to finish your project.

| | | |
|-------------------------------|----------|------------------------|
| Shed Felt | 10m x 1m | £31.95 per roll |
| Heavy Duty Green Mineral Felt | 10m x 1m | £45.00 per roll |
| Torch On Felt | 8m x 1m | £65.00 per roll |
| Underlay | 16m x 1m | £65.00 per roll |

All prices include VAT

The Mill

Alongside stocking timber and making bespoke sheds and summer houses to your specifications, we also provide additional 'timber cutting' services.

In our mill:

- We specialise and stock a vast number of ready-made mouldings and profiles
- We also offer a service that allows you to have your own wood sample duplicated
- Our skilled team can also produce a CNC template from your own sample and create bespoke profile knives to help you make a custom-made moulding for any project, using top-of-the-line precision grinding and moulding equipment from Weing.

In our workshop, our high-quality equipment and fully trained staff can:

- Save you considerable time and effort by cutting your timber to a specific size
- Cut hardwood and softwood to your precise specifications
- Supply, cut, and install all gates, fencing, decking and sheds to several different designs.



CNC Milling,
Turning and
Cutting available
for bespoke
profiles

Fence Panels and Timber Gravel Boards

HD Waney Panel



HD Close Board Panel



| Pressure Treated Heavy Duty Waney Edge Fence Panels | |
|---|--------|
| 6ft x 6ft | £35.65 |
| 6ft x 5ft, 6in | £35.65 |
| 6ft x 5ft | £31.95 |
| 6ft x 4ft | £29.00 |
| 6ft x 3ft | £26.95 |
| 6ft x 2ft, 6in | £25.65 |
| 6ft x 2ft | £21.25 |

| Pressure Treated Heavy Duty Close boarded Fence Panels | |
|--|--------|
| 6ft x 6ft | £40.00 |
| 6ft x 5ft, 6in | £38.15 |
| 6ft x 5ft | £33.65 |
| 6ft x 4ft | £29.75 |
| 6ft x 3ft | £25.85 |

Shaped Tops & Trellis, add £5.00 each

Gravel Boards



| Timber Gravel Boards | |
|----------------------|--------|
| 6ft x 6in x 1in | £4.95 |
| 6ft x 6in x 2in | £12.75 |
| 6ft x 9in x 2in | £19.15 |

For concrete gravel boards and posts, see page 22-23.

European Panel



| European Fence Panels | |
|---------------------------|---------------|
| 1.8m (w) x 1.8 / 1.6m (h) | £86.95 |
| 1.8m (w) x 1.5 / 1.3m (h) | £74.83 |
| 1.8m (w) x 1.2 / 1.0m (h) | £64.37 |
| 1.8m (w) x 0.9 / 0.7m (h) | £61.06 |

HD Palisade Panel



| Pressure Treated Heavy Duty Palisade Fence Panels | |
|---|---------------|
| 6ft x 6ft | £41.10 |
| 6ft x 5ft | £36.35 |
| 6ft x 4ft | £31.00 |
| 6ft x 3ft | £25.00 |
| 6ft x 2ft | £20.25 |
| 6ft x 1ft | £15.25 |

Made with 3x1 treated timber

Fence Accessories

We supply all fence accessories to finish your project.

| Ornamental Post Finials | | |
|-------------------------|------------|-------------------|
| 100mm | Angled Cap | £1.00 each |
| 125mm | Angled Cap | £2.00 each |

| Misc | |
|---------------|---------------------------|
| Panel Caps | £2.50 each (brown) |
| Fence Battens | 25p per foot |
| Post Mix | £6.75 per bag |
| Cement | £5.50 per bag |
| Builders Sand | £2.05 per bag |
| Sharp Sand | £2.05 per bag |
| Ballast | £2.50 per bag |



All prices include VAT

Trellis Panels

HD Trellis

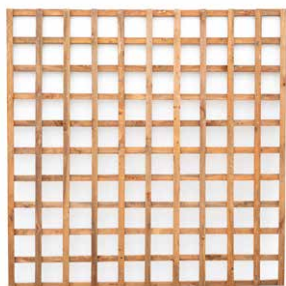

Concave & Convex Trellis

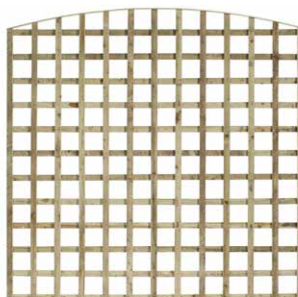

Heavy Duty Trellis

| | |
|-------------|-------------|
| 6ft x 1ft | £10.90 each |
| 6ft x 1.5ft | £11.50 each |
| 6ft x 2ft | £13.05 each |
| 6ft x 3ft | £16.10 each |
| 6ft x 4ft | £17.55 each |
| 6ft x 5ft | £21.40 each |
| 6ft x 6ft | £24.45 each |

Concave & Convex Trellis

| | |
|-------------|-------------|
| 6ft x 1ft | £15.90 each |
| 6ft x 1.5ft | £16.50 each |
| 6ft x 2ft | £18.05 each |
| 6ft x 3ft | £21.10 each |
| 6ft x 4ft | £22.55 each |
| 6ft x 5ft | £26.40 each |
| 6ft x 6ft | £29.45 each |



Special prices on application.

Squares in the trellis are made to approx. sizes of 6-inch gaps. Smaller privacy gaps can be made if required. Please contact in store for details and prices.

Gates

| Gates | |
|------------|---------|
| 6ft x 4ft | £110.00 |
| 6ft x 3ft | £85.00 |
| 6ft x 33in | £75.00 |
| 6ft x 30in | £70.00 |
| 6ft x 2ft | £55.00 |
| 5ft x 3ft | £55.00 |
| 4ft x 3ft | £50.00 |
| 3ft x 3ft | £45.00 |

Plus £5.00 for arched tops

We supply all wooden gates made to your design and requirements. These can also be installed and erected in place, as an extra charge.

Contact us for more information.



All prices include VAT

Posts, Poles, Sleepers & Trellis Panels

Woodern Posts and Poles



| Pressure Treated 3" x 3" 75 x 75 Wooden Posts | |
|--|-------------|
| 5ft - 1.5 | £5.30 each |
| 6ft - 1.8 | £6.35 each |
| 7ft - 2.1 | £7.40 each |
| 8ft - 2.4 | £8.50 each |
| 9ft - 2.7 | £9.55 each |
| 10ft - 3.0 | £10.60 each |

| Pressure Treated 4" x 4" 100 x 100 Wooden Posts | |
|--|-------------|
| 5ft - 1.5 | £9.40 each |
| 6ft - 1.8 | £11.25 each |
| 7ft - 2.1 | £13.15 each |
| 8ft - 2.4 | £15.00 each |
| 9ft - 2.7 | £16.90 each |
| 10ft - 3.0 | £18.80 each |



| Round Poles | |
|-------------|-------------|
| 50 x 1.80 | £4.50 each |
| 50 x 2.40 | £4.95 each |
| 75 x 1.80 | £5.95 each |
| 75 x 2.40 | £6.95 each |
| 100 x 1.80 | £10.30 each |
| 100 x 2.40 | £13.60 each |
| 150 x 1.20 | £16.50 each |

| Gate Posts | |
|-----------------|-------------|
| 2.4 - 125 x 125 | £24.95 each |
| 2.4 - 150 x 150 | £35.25 each |
| 3.0 - 150 x 150 | £44.25 each |
| 2.4 - 175 x 175 | £47.95 each |
| 2.4 - 200 x 200 | £62.95 each |

Railway Sleepers



| Railway Sleepers | |
|-----------------------|--------|
| 200 x 100 x 2.4 | £29.45 |
| 250 x 125 x 2.4 | £44.10 |
| 200 x 100 x 2.4 (Oak) | £42.50 |

Fan Trellis Panels



| Fan Trellis Panels | |
|-----------------------|-------------|
| 6ft x 3ft Fan Trellis | £20.95 each |

Concrete Posts & Gravel Boards

Fence Posts



| Concrete Posts | |
|---------------------------|---------------|
| 10ft Inters - 2.90 metres | £37.70 |
| 9ft Inters - 2.66 metres | £25.45 |
| 8ft Inters - 2.36 metres | £23.95 |
| 7ft Inters - 2.05 metres | £23.30 |
| 6ft Inters - 1.75 metres | £22.95 |
| 5ft Inters - 1.4 metres | £21.80 |
| End Posts | Post + £5.00 |
| Corner Posts | Post + £8.00 |
| Three Way | Post + £10.00 |

Gravel Boards



| Concrete Gravel Boards / Spurs | |
|--------------------------------|------------------|
| 6ft x 12" Solid | £23.05 |
| 6ft x 12" Recessed Type | £21.65 |
| 6ft x 6" Solid | £14.85 |
| 8ft x 6" Solid to order | Price on request |
| Spurs - 3'6" x 3" x 3" | £11.00 |
| Spurs - 4'0" x 4" x 4" | £13.95 |

All prices include VAT

Concrete Posts & Gravel Boards

Liquunt ditaquia
 dolorem sumquae non
 eaqui bla qui nis verrum
 ium, conseri bearciis
 dolupta sperita tissintur,
 volorpo remquunt
 volorate porehendus
 sam, simi, quam, sinis
 venti dolorum ipsam,
 nobis etur aperspe
 iduntemque nonsect
 ureperciis et laborio
 nseque dolorerum
 facimusam harum.



Coloured Fence Posts



| Coloured Concrete Posts | |
|---------------------------|---------------|
| 10ft Inters - 2.90 metres | £37.70 |
| 9ft Inters - 2.66 metres | £25.45 |
| 8ft Inters - 2.36 metres | £23.95 |
| 7ft Inters - 2.05 metres | £23.30 |
| 6ft Inters - 1.75 metres | £22.95 |
| 5ft Inters - 1.4 metres | £21.80 |
| End Posts | Post + £5.00 |
| Corner Posts | Post + £8.00 |
| Three Way | Post + £10.00 |

Coloured Gravel Boards



| Coloured Concrete Gravel Boards | |
|---------------------------------|--------|
| 6ft x 12" Solid | £23.05 |
| 6ft x 12" Recessed Type | £21.65 |
| 6ft x 6" Solid | £14.85 |

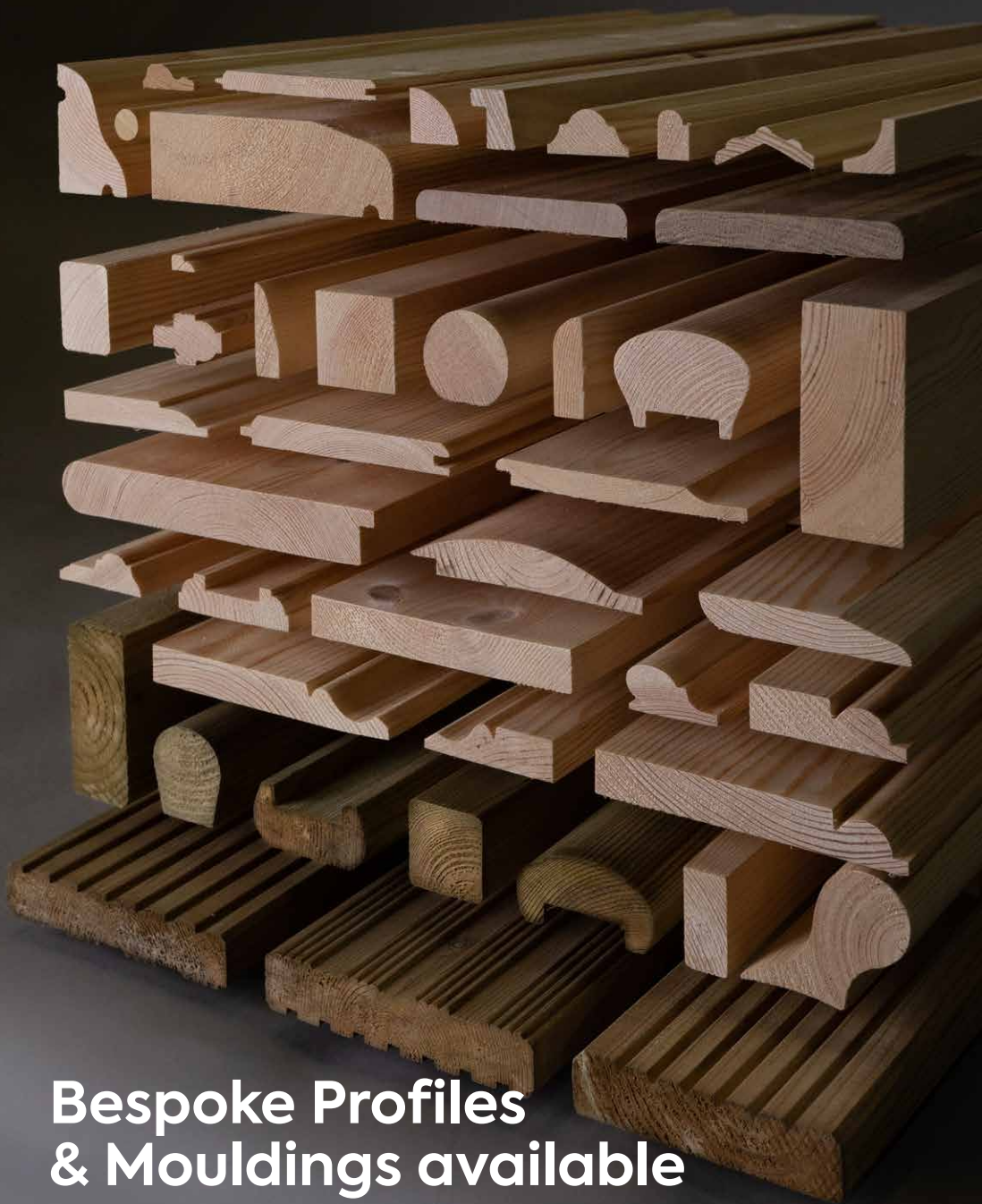

Bespoke Profiles & Mouldings available

Call us on: 01255 427654 • Email: sales@patternsnetwork.co.uk

METPOST Supports, Spurs and Clips

METPOST Post Supports



| METPOST Post Supports | |
|-----------------------|-------------|
| 30in x 3in x 3in | To order |
| 30in x 4in x 4in | £12.99 each |
| 24in x 3in x 3in | £10.80 each |
| 18in x 2in x 2in | £8.00 each |

| Concrete-in Post Supports | |
|---------------------------|-------------|
| 3in x 3in | £9.50 each |
| 4in x 4in | £11.45 each |

METPOST Repair Spurs/Clips



| METPOST Repair Spurs / Clips | |
|------------------------------|-------------|
| Spurs - 3in x 3in | £10.95 each |
| Spurs - 4in x 4in | £14.95 each |
| Clips - size 38mm | 65p each |
| Clips - size 44mm | 65p each |

| METPOST Bolt-Down Post Supports | |
|---------------------------------|-------------|
| 3in x 3in | £8.00 each |
| 4in x 4in | £10.25 each |
| 2in x 2in | £7.50 each |

Loft Ladders & Windows

We can supply a full range of quality Fakro Loft Ladders, roof windows, blinds and screens.

Contact us for more information.



Prices start from
£189

All prices include VAT

Terms & Conditions

DELIVERY: There will be a delivery charge on all orders **under £100.00**. This may be waived or changed at the salesperson's discretion. All orders are front door delivery only unless pre-arranged with the salesperson taking your order. If in doubt, please check.

TIMBER SIZES: All timber sizes are nominal unless otherwise stated.

CLAIMS: The number of bundles and boards and their condition should be checked on arrival. Claims for shortages or damage in transit **MUST BE MADE AT THE SAME TIME**.

TIME OF DELIVERY: Claims not applying to shortages or damage in transit will be given consideration providing, they are made **WITHIN THREE DAYS OF DELIVERY**.

CANCELLATIONS: Orders cancelled after loading or dispatch will be liable to a re-handling charge of 30% of the order value (minimum £30). This also applies to goods incorrectly ordered, not required, or returned without prior consultation. For any specials, we will require the full sale price.

CREDITS: Bona fide claims will be dealt with within 24 hours of notification by way of credit note, unless goods require inspection, in which case our representative will call within five working days.

DELIVERIES: We reserve the right to make delivery by instalments and render a separate invoice for each such instalment. If we exercise our right to make such a delivery, any delay in delivering or failure to deliver further instalments shall not entitle you to reject the contract or delivery of any other instalments, or to withhold payment in respect of any instalment previously delivered.

LENGTHS: Please give us as much option on length as you can. Minimum and maximum lengths are essential. If a specific length can only be produced by cutting to waste, the full length will be charged.

LIABILITY: Goods are not tested as fit for any particular purpose. We shall not be liable for any warp, shrinkage, splitting, waste, or any other movement caused by temperature, humidity, or any other condition. In no circumstances whatsoever shall our company's liability to our customer arising under, out of or in connection with the goods supplied, exceed the invoice price of the piece(s) in regard to which a complaint is found to be valid.

TITLE TO GOODS: The ownership of all goods remains with Pat'erns Network UK Limited until full payment has been made. The company reserves the right to repossess goods not paid for. The risk in the goods passes to you on delivery.

TAKING CARE OF YOUR NEW TIMBER PRODUCTS

As timber is a natural material it is important that during dry weather, and the first year after installation or during storage, that the panels are wetted down regularly as with a newly planted tree or shrub.

Treat your panels annually with one of the popular treatments we recommend or any similar water-based preservative.

Panels are delivered already dipped and treated. However, if you need to retreat to colour match, both sides of the panel must be treated as warping can occur due to the uneven application of treatment.

Large timbers such as posts will crack or split, this unavoidable.

It is impossible for us to guarantee our products against the movement of wood as this is a natural reaction to moisture loss and is obviously out of our control. We do however, endeavour to maintain the highest standards in the construction of our fencing, gates and timber buildings and trust that they will give you long and continued good service.

Pat'erns

Network UK Ltd.

The largest supplier of timber products in the area

BEST ON
PRICE
& QUALITY



DELIVERY

We offer a delivery service for customers. There is a delivery charge on all orders under the value of £100.

Gorse Lane Industrial Estate,
Stephenson Road,
Clacton-on-Sea,
Essex, CO15 4XA

Telephone: 01255 427654
email: sales@paternsnetwork.co.uk
www.paternsnetwork.co.uk



OPENING TIMES

Monday to Friday: 8am - 5pm
Saturday: 8am - 1pm